

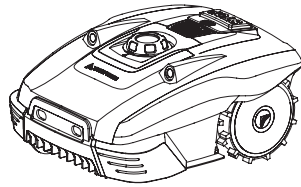

**ROBOTIC MOWER**

Installation Guide

**COMPACT 280R**



+44(0)1904 727513

support@yardforce.co.uk

www.yardforce.eu



Nov. 2019  
V2.0

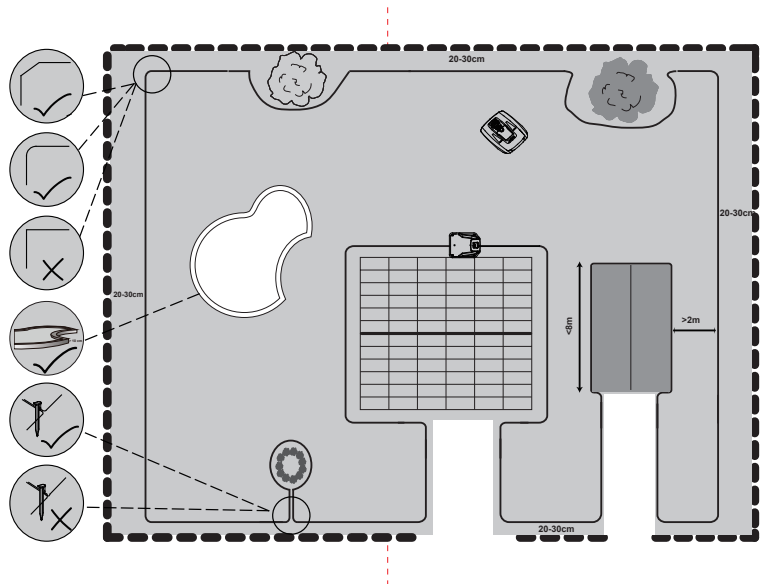

# CONTENT

Description of product ..... 1  
 Installation ..... 2  
 Operation ..... 10  
 Technical data ..... 13  
 Maintenance and storage ..... 14  
 Troubleshooting ..... 16  
 Warranty ..... 17

## Description of product

1. STOP button
2. Ultrasonic sensor
3. Charging port
4. Rear wheel
5. Height adjustment dial
6. Control panel
7. USB interface
8. On/Off switch

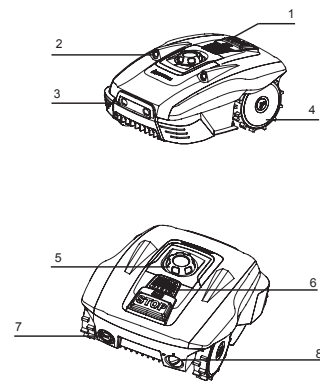

## Parts included within this box

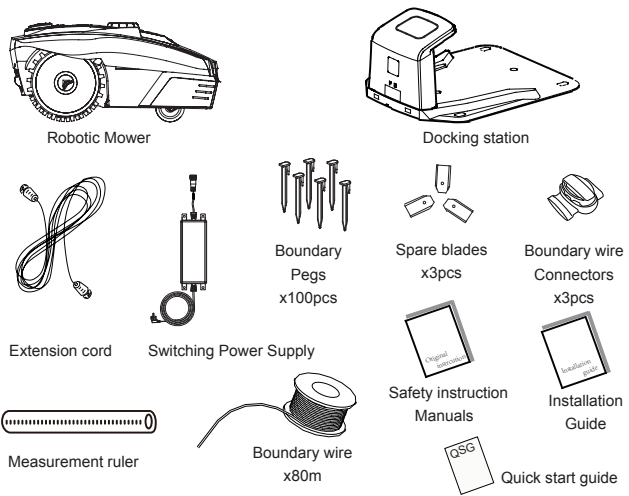

## Installation

### Installation Guide

This chapter explains how to install the Robotic Mower. Please read this fully before you start the installation.

### Before you begin

We recommend creating a sketch of the lawned area you plan to mow on paper before you begin installation. Make sure you include all obstacles, such as bushes, flower beds, and paving. This will give you a visual representation of how to correctly place the boundary wire around your garden perimeter. Make sure you have a hammer, wire cutters, pliers or scissors to hand.

### Avoiding Obstacles

The Robotic Mower is equipped with ultrasonic sensors. These will detect any rigid and fixed obstacles higher than 100mm, such as walls, fences, and garden furniture. When triggered, the Robotic Mower will stop, reverse backwards and then continue mowing in a different direction. Make sure you lay the boundary wire correctly to ensure the machine avoids obstacles.

### Trees

The Robotic Mower treats trees as common obstacles, however if the tree roots are exposed and lower than 100mm they will need to be excluded from the mowing area with the boundary wire. This is to avoid damaging the root, blades, or rear wheels.

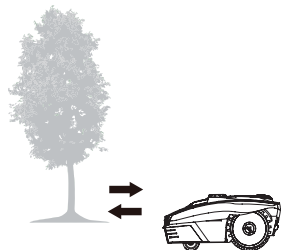

### Stones

We recommend clearing the lawn of small rocks and stones and any stones with a round or sloped edge. The Robotic Mower might try and climb such rocks instead of recognising them as a barrier. A Robotic Mower getting stuck on such a stone requires user intervention to restart mowing. Contact with stones can result in damage to the blades.

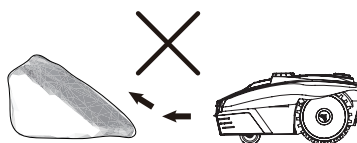

### Slopes

The Robotic Mower can navigate slopes up to a maximum of 30% incline or decline.

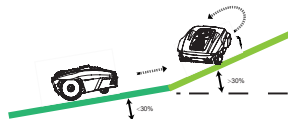

### Paths, Driveways and Roads

If you have an elevated driveway or walk way which crosses through your lawn, you will need to exclude this from the cutting area. Remember to allow a safety distance of 40cm between the elevated area and the boundary wire.

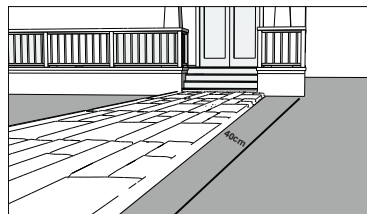

If the driveway and lawn are at the same level, feel free to use the boundary wire to create a corridor. This allows your Robotic Mower to cross the driveway and reach the opposite lawn.

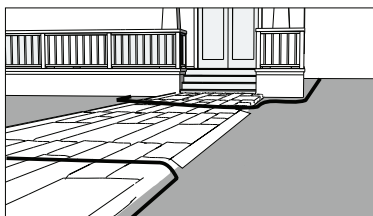

**Uneven lawn surfaces**

Uneven lawn areas may cause the blades to touch the ground. We recommend levelling the lawn before using your Robotic Mower or excluding uneven areas with the boundary wire.

**Placing the docking station**

Your docking station will need a permanent connection to mains power, so make sure you place it in the nearest location possible.

To ensure the Robotic Mower can return to the docking station smoothly, leave 2m of straight wire to the front of the docking station and 50cm to the side facing the cutting area. Use a shaded location for the docking station, as a lower temperature while charging is beneficial to the battery. Important: Place the docking station on an even, flat surface away from ponds, pools or stairs. We recommend suitable protection from the elements, for example a robot port or garage.

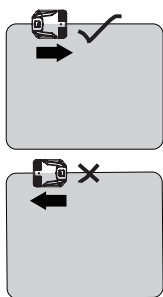
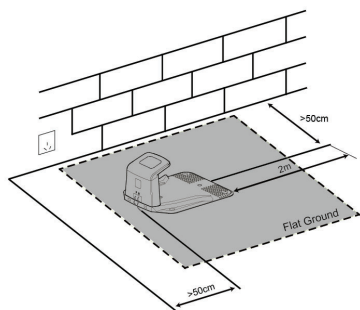

Do not place the docking station too close to a slope, such as at the top of a hill or the bottom of a furrow. Avoid left and right inclination in excess of 5 degrees.

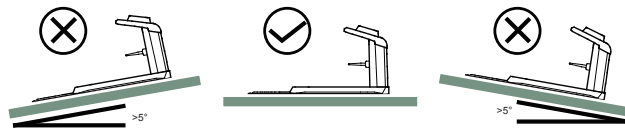

If your lawn has a soft or uneven surface, we recommend fortifying the area around the docking station with a grass protection mesh. Otherwise, the repeated stress of the rear wheels can damage the turf.

Once the position of the docking station is confirmed and mains electrical connection is laid out, please do not connect to main power yet. Finish all boundary layout work before connecting the docking station to the power supply.

**Pegging your boundary wire**

We strongly recommend mowing the lawn to 60mm or less before laying out the boundary wire. Burying the boundary wire is entirely optional. Still, the closer to the ground you lay out the boundary wire, the lower the chance of tripping over it or damaging it when mowing the lawn. Use the ruler (included on the packaging) to ensure the required 20-30cm distance between wire and obstacles.

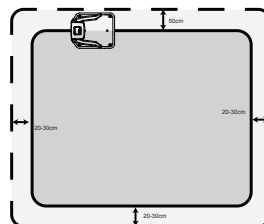

The recommended distance between two pegs is about 80cm in straight lines, and less in tight curves. Note that the pegs' hook and wire slit always faces the outside of the boundary.

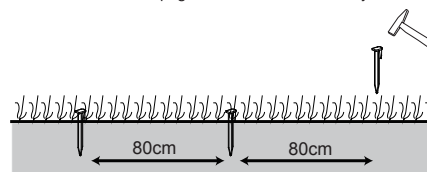

When initially placing the pegs, do not drive them fully into the ground. Use a light hammer to drive them in a little bit. Also locate the fixing pegs and lay each one on the lawn at approximately the correct distance from lawn edges (20-30cm) and obstacles.

### Flowerbeds

Use the boundary wire to exclude any flowerbeds from the cutting area. There are two options for the two lengths of boundary wire running between the flowerbed and the outer boundary:

1) Keep the distance between the parallel wires above 10cm. This way, the Robotic Mower will recognise the boundary wire as an ordinary obstacle. When cutting, it will "bounce" off it as expected. When following the boundary wire back to the docking station, it will take the detour around the flower bed.

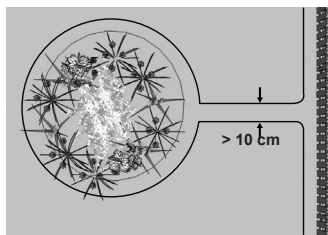

2) Alternatively, keep the distance between the two parallel wires below 5mm. Do not cross the wires - see below. This way, the Robotic Mower will not recognise the wires and travel across them unhindered. This option requires placing an obstacle on the boundary wire around the flowerbed. Place the obstacle, e. g. a large rock or pole, near **position A** indicated on the below illustration. The obstacle must be surrounded by a flat area of about 1m x 1m, without any slopes. This obstacle will allow the machine to exit the circle.

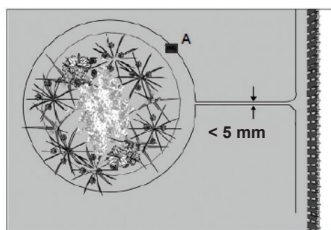

### Ponds and Pools

While the Robotic Mower is protected against rain and spray water, being submerged is likely to cause severe damage to the electronic parts.

Therefore, it is imperative to exclude any open water sources from the cutting area. For added safety, we recommend placing a fence around any water.

### Boundary Corridors

If you have created a boundary corridor inside your working area, the corridor should be at least 2 m wide and a max length of 8 m.

If a corridor is too narrow or too long, the Robotic Mower might not be able to navigate it from one end to the other.

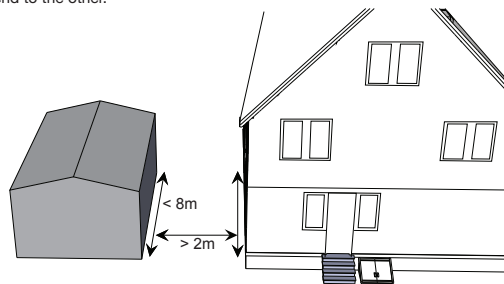

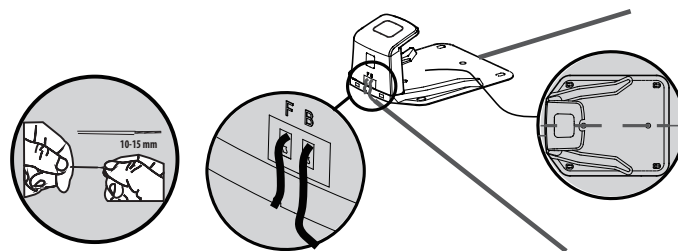

### Connect the docking station to the boundary wire

Run the boundary wire underneath the front of the docking station and connect the end of the wire to the left (black) connector marked 'F' (front). After you have placed the wire around the garden then place the other end into right (red) connector marked 'B' (back).



Once the blue LED confirms all is OK, test the Robotic Mower's function. Check the LED regularly to ensure fixing the boundary wire has not affected the connection and signal shows S1 on the charging station. Then place the Robotic Mower in the working area, a few metres beside the docking station. Set the main power switch to "ON".

First press the buttons  and then , a few seconds later, the Robotic Mower should automatically return to the docking station by locating and following the boundary wire in anti-clockwise direction. If Robotic Mower fails to dock correctly, move the docking station to a more suitable position.

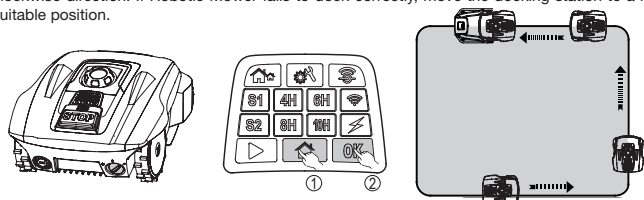

Once the device has docked, the symbol will start flashing. This indicates that the battery is charging correctly.

After initial installation, the Robotic Mower will remain in the docking station until the battery is fully charged.

Successful docking and charging indicates that you have found a suitable position for the docking station. You should now start fixing pegs into ground fully. Take care not to damage or kink the surplus wire stored under the docking station.

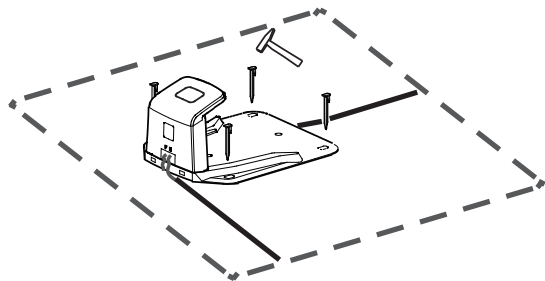

### Signal selection

There are two signals which can be selected, S1 (blue indicator) and S2 (red indicator). Make sure your Robotic Mower and docking station are using the same signal.

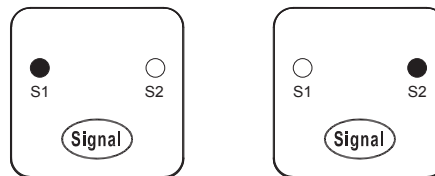

If your neighbour is using the same robotic mower, will need to keep a distance of 0.5m between you and your neighbour's boundary wires to prevent the two devices interfering with each other. Ensure to position your docking station at least 10m away from your neighbour's boundary wires and that both products are using different signals. Please refer to section "Signal setting" in order to select signal S1 or S2 for your installation.

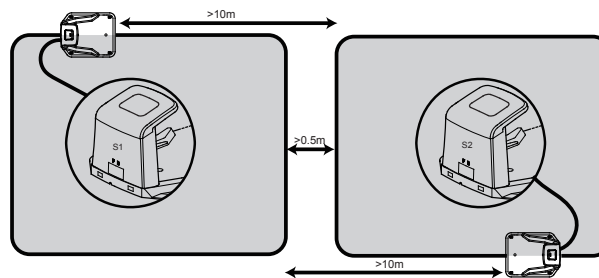

# Operation

## Control panel

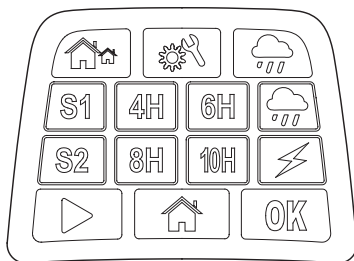

**Signal select button:**  
Select either S1 or S2.



**Working time select button:**  
Select working time.

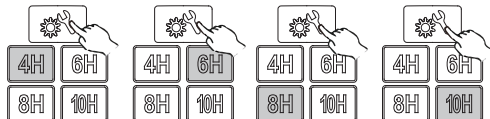

**Rain sensor button:**  
Switch rain sensor ON/OFF.



**Charging indicator:**  
Flashes when Charging

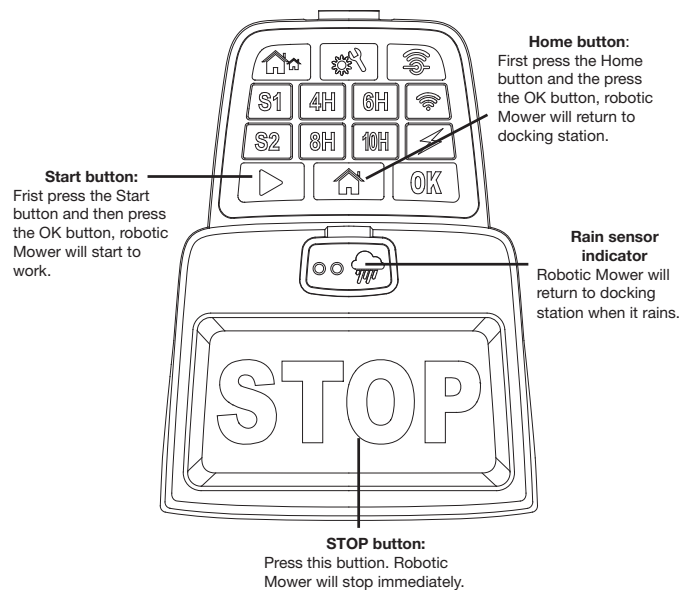

## Start mowing

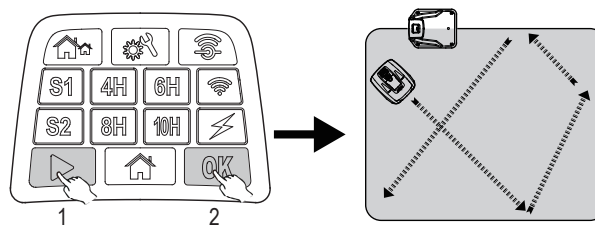

First press the play button, then press the OK button.

### Return to Docking station

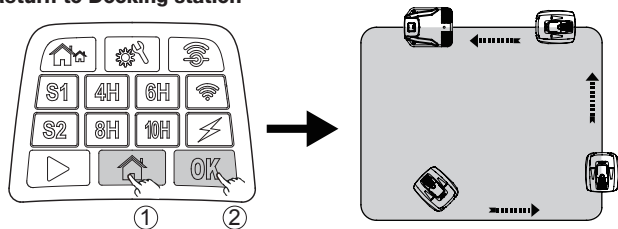

First press the button, then press button.

### Emergency Stop

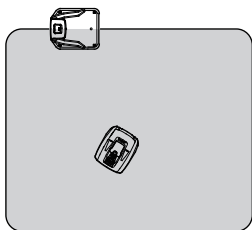

Press STOP button to halt the mower at any time.

### Cutting height adjustment

The cutting height can be adjusted by rotating the height adjustment dial located on the top of the machine. Cutting height range from 20mm - 55mm.

#### NOTE!

We recommend using an ordinary lawn mower or trimmer to cut the lawn below 45mm before using the Robotic Mower. This will ensure you get the optimum performance.

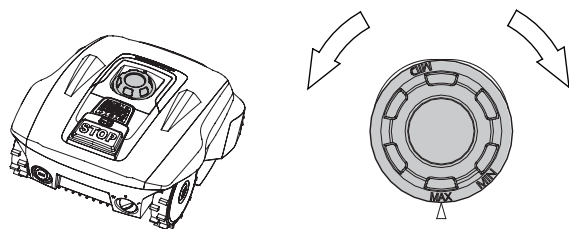

### Technical Data

<b>Model</b>	<b>Compact 280R</b>
Max cutting area	280 m <sup>2</sup>
Battery pack	20V/2000mAh
Switch power supply	Input: 100-240V AC, 50/60Hz, 42W Output: 24VDC, CC1.5A
Mowing time on one charge	60 min
Rated voltage	20 V
Rated power	42 W
No load speed	3500/min
Cutting width	16 cm
Cutting height	Approx 20-55 mm
Charging time	100 min
Weight	7.4 Kg
<b>Degree of protection:</b>	
Robotic Mower	IP24
Switching power supply	IP67, Plug IP44
<b>Spare parts</b>	
Spare Blades	3 Pcs
Boundary pegs	100 Pcs
Boundary wire	80 m
Connectors	3 Pcs



## Maintenance and storage

Maintenance works that have not been instructed within the manual should only be carried out by a recommended servicing agency. Only use original parts.

### Maintenance

Check and clean your Robotic Mower Regularly. Preferably use a dry brush, damp cloth or a sharpened wooden piece to remove any debris which may be stuck. Do not clean with a hose or the high pressure water flow from a pressure washer as this may cause damage. Replace worn parts as necessary.

### Winter Storage

During winter, keep your mower, docking station and power supply in a dry place. We recommend a shed, garage or preferably store it indoors.

Prepare your device for winter storage as follows:

1. Fully recharge the battery.
2. Set the mains power switch to "OFF".
3. Thoroughly clean your Robotic Mower.
4. Unplug the power supply from the mains outlet.
5. Disconnect the power supply from the docking station.
6. Disconnect the boundary wire from the docking station. Lift up the docking station and clean. The boundary wire can remain outside. However, it is imperative to protect the wire against corrosion. We recommend a water-free grease or suitable sealing tape.

If available, repack the product in the original packaging.

Alternatively, our service centre offers a winter service for your device. This will include a check-up of all parts and - if available - a software upgrade.

### Preparing for spring

After winter storage, please clean the charging contacts on both the Robotic Mower and the docking station.

Use a fine abrasion paper or a brass brush; this will help to achieve the best charging efficiency and avoid any charging interference.

### Cleaning the mower body

As your Robotic Mower is battery powered you need take care when cleaning. Remove rough dirt with a soft brush. Use a manual water spray with mild household detergent for intensive cleaning. Wipe off any residue after cleaning with a damp cloth.

### Cleaning the underside

Ensure the main power switch is in OFF position. Wearing protective gloves, turn the Robotic Mower onto its side to expose its underside. Clean the blade disc and frame using a soft brush or damp cloth. Rotate the blade disc to make sure that it can move freely, check that the blades can turn on their pivots and that there is no grass is obstructing them.

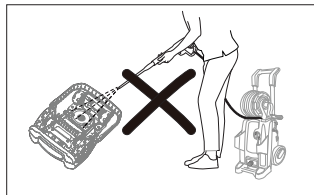

### Clean the contact pins and the charging strips

Using wire wool, metal cleaner or very fine grade emery paper, clean the contact pins and the charging strips on your mower and docking station. Remove any debris, leaves, or grass clippings around the contact pins and charging strips to ensure efficient charging.

### Reversing or replacing the blades



#### WARNING!

Ensure the Robotic Mower is completely shut off before cleaning, adjusting or replacing the blades. Always wear protective gloves.



#### WARNING!

To ensure maximum cutting efficiency and safety, always use recommended replacement blades and blade mounting parts when replacing.

Your Robotic Mower has three blades, fixed to the blades disk.

Unless damaged by hard obstacles, these blades can last for up to five months of everyday use. Weekly inspection of the blades and the fixing screws is advised. Note that the blades are double-edged. When the first side becomes blunt, loosen the fixing screw and the blade upside down and re-fix. Check that the blade can move freely.

A set of spare blades is included with the Robotic Mower. More blades can be purchased via our customer support team or our website [www.yardforce.eu](http://www.yardforce.eu).

To ensure you get the best performance from your machine, always replace all three blades at the same time. Only use spare parts recommended by manufacturer.

### Spare parts list

Call the customer support team on 01904 727 513 if you want to order below spare parts.



Boundary pegs



Spare blades



Boundary wire connectors



Boundary wire

### Software Update

Should your machine need a software update, contact our customer support team for more information.

## Troubleshooting

### Robotic Mower cannot dock with docking station

- Check that the boundary wire in front and underneath the charger is in a straight line.
- Check that the docking station's position is suitable as explained in this manual.

### Robotic Mower runs in circles while mowing or while following boundary wire back to docking station.

- Verify that no power cable runs parallel and in close proximity the boundary wire. If necessary, reposition the boundary wire.
- Check if a front wheel is stuck.
- If a neighbor has a similar Robotic Mower, the signals may interfere. Try setting your docking station and Robotic Mower to the alternative boundary signal.
- Driving motor may be damaged, please contact our customer support team.

### The Robotic Mower is noisy.





- Inspect the blade fixing screws; tighten if necessary.
- Inspect the blades for damage; replace if necessary.
- Grass may be too high. Try increasing the cutting height, or mow the lawn with an ordinary lawnmower first.
- Cutting motor failure, please call our customer support team.

### Mower remains at or returns to docking station when pressing START button

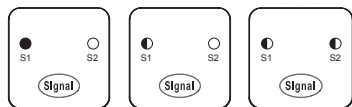
- Check if the mower has already completed the programmed working time for that day.
- Battery is low, give the Robotic Mower time to charge and try again.

### LED signal indicator on docking station

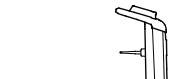

Status	LED Indicator ON	LED Indicator flashing
	Battery charging faulty 	Normal 
	Normal 	Boundary wire broken 

## Warranty

### Yard Force Warranty Statement.

All Yard Force products are covered by a standard two-year warranty which can be extended to three years if the product is registered online within 28 days of purchase. If you do not register your product within 28 days of purchase, the two-year warranty will apply. Battery packs are guaranteed for 1 year.

If your product becomes faulty within the warranty period due to defective materials or workmanship we will guarantee to

- Repair or replace all defective parts free of charge
- Repair product free of charge
- Replace the unit with a new or re-conditioned unit free of charge

### Our 3 Year\* warranty is subject to the following conditions:

- The machine has only been used for domestic tasks and has not be used in industrial applications
- The machine has not been misused
- The machine has been subjected to fair wear and tear only and has not been tampered with or modified in any way.
- Unauthorised repairs have not been attempted

### Your warranty does not cover:

- Components that are subject to natural wear and tear cause by normal use of the machine in line with the operating instructions, such as consumable parts and accessories
- Damage caused through negligence, abnormal working conditions or due to wilful actions of the operator
- Damage caused by using non-recommended spare parts or accessories
- Machines to which unauthorised changes or additions have been made
- Battery packs are not properly maintained (see instruction manual).

\*Standard 2 year warranty, plus additional 1 year warranty if product registered on line at [www.yardforce.eu](http://www.yardforce.eu), within 28 days of purchase, against a valid proof of purchase receipt



+44(0)1904 727513



support@yardforce.co.uk

[www.yardforce.eu](http://www.yardforce.eu)